

DELTA-AX ACTIVE SERIES

ACTIVE LOUDSPEAKERS

DELTA-AX12 DELTA-AX15 DELTA-AX15B DELTA-AX18B



www.wharfedalepro.com

TABLE OF CONTENTS

Important warnings & safety instructions	1
Introduction and Key features	2
DELTA-AX12 DELTA-AX15 Rear panel layout	3 - 4
DELTA-AX15B DELTA-AX18B Rear panel layout	5
Dimensional drawings	6 - 7
Specifications	8 - 9

IMPORTANT WARNINGS & SAFETY INSTRUCTIONS

1. Read these instructions
2. Follow all instructions
3. Keep these instructions
4. Heed all warnings
5. Do not use this apparatus near water
6. Clean only with dry cloth.
7. Do not block any ventilation openings. Install in accordance with the manufacturer's instructions.
8. Do not install near any heat sources such as radiators, heat registers, stoves, or other apparatus (including amplifiers) that produce heat.
9. Do not defeat the safety purpose of a polarised or grounding plug. A polarised plug has two blades with one wider than the other. A grounding plug has two blades and a third grounding blade. The wide blade or the third blade is provided for your safety. If the provided plug does not fit into your outlet, consult an electrician for replacement of the obsolete outlet.
10. Protect the power cord from being walked on or pinched, particularly at the plug, receptacle and or the point where it exits from the apparatus.
11. Only use attachments/accessories specified by the manufacturer.
12. Only use a stand, tripod, bracket or rack specified by the manufacturer, or sold with the apparatus. When a rack is used, use caution when moving the rack and apparatus combination to avoid tip-over or injury.



13. Unplug the apparatus during lightning storms or when unused for long periods of time.
14. Refer all servicing to qualified personnel. Servicing is required when the apparatus has been damaged in any way including but not limited to power supply cord or plug damage, liquid ingress, foreign objects in the chassis, exposure to rain/moisture or impact damage. In addition the unit must be serviced when you experience any abnormal operation.
15. CAUTION: These servicing instructions are for use by qualified service personnel only. To reduce the risk of electric shock, do not attempt to perform any servicing other than that contained in the operating instructions unless you are qualified to do so. In addition opening the casing will result in your warranty becoming null and void.
16. Do not install this apparatus in a confined space such as a book case or similar unit. Good ventilation should be maintained around the apparatus. Any vents, air-inlets or fans should not be obstructed by objects such as paper, table-cloths, curtains etc.
17. WARNING: To reduce the risk of fire or electric shock, do not expose the apparatus to rain or moisture. The apparatus should not be exposed to dripping or splashing and objects filled with liquids, such as vases, should not be placed on the apparatus.
18. WARNING: Do not use the mains plug/appliance coupler to power on or off the device. Use the ON / OFF switch.

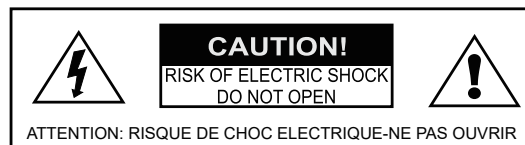

19. The lightning flash with arrowhead symbol within an equilateral triangle is intended to alert the user to the presence of non-insulated "dangerous voltage" within the product's enclosure that may be of sufficient magnitude to constitute a risk of electric shock.
 - Warning: To reduce the risk of electric shock, do not remove the cover (or back) as there are no user-serviceable parts inside. Refer servicing to qualified personnel.
 - The exclamation point within an equilateral triangle is intended to alert the user to the presence of important operating and maintenance instructions in the literature accompanying the appliance.
20.  (Protective earthing terminal) The apparatus should be connected to a mains socket outlet with a protective earthing connection.

21.  Correct Disposal of this product. This marking indicates that this product should not be disposed with other household wastes throughout the EU. To prevent possible harm to the environment or human health from uncontrolled waste disposal, recycle it responsibly to promote the sustainable reuse of material resources. To return your used device, please use local return and collection systems or contact the retailer where the product was purchased. They can take this product for safe environmentally friendly recycling.

INTRODUCTION

DELTA-AX is the next generation of the world famous Wharfedale Pro Delta Series. Specifically designed as a multipurpose solution, DELTA-AX provides high-end active sound reinforcement for touring applications and professional musicians. By combining our legendary audio quality, renowned durability and affordability, DELTA-AX sets a new standard in the category of active loudspeakers. Capable of producing extraordinary sound pressure levels, inside every DELTA active speaker is a high head room amplifier exclusively engineered by Wharfedale Pro. High Output, low distortion woofers are used throughout the range for unparalleled frequency reproduction. In addition, the 2" titanium compression drivers used in the 2 way models offer impressive output level and smooth HF dispersion. DELTA-AX 2 way models also feature an integrated two channel mixer with onboard Qubit DSP insuring smoother more controlled sonic performance.

KEY FEATURES

DELTA-AX12 & DELTA-AX15

- 2-way Bi-Amplified speaker system
- Low frequency power amplifier 650W RMS, 1300W peak (CLASS D)
- High frequency power amplifier 100W RMS, 200W peak (CLASS D)
- 28/56-bit, 192kHz DSP processing
- Independent LF and HF signal limiting
- Thermal, DC and short circuit fault protections
- Bass / Treble EQ controls
- Switchable 90Hz monitor filter
- Combo XLR/1/4" jack balanced line or mic inputs
- Female XLR balanced line level output
- Rear panel mic/line level switch
- Rear panel front LED defeat switch
- Remote volume control (applied voltage controlled)
- 90° x 45° elliptical Wave Guide (EWG)
- Dual-angle (0° or 10°) 35mm pole socket
- Suspension points 6 x M10 threaded.
- Black rhino paint finish
- 15mm plywood construction
- Dual line level RCA inputs

DELTA-AX15B

- 15" Active subwoofer
- Low frequency power amplifier 900W RMS, 1800W peak,(Class D)
- 130dB Max SPL
- High headroom class D amplifier
- 42-200Hz frequency response
- 15" woofer with 4" voice coil
- Adjustable crossover: 80Hz-200Hz
- 100Hz high pass filter output
- Integral phase switch 0° and 180°

DELTA-AX18B

- 18" Active subwoofer
- Low frequency power amplifier 1000W RMS, 2000W peak,(Class D)
- 132dB Max SPL
- High headroom amplifier
- 38-200Hz frequency response
- 18" Woofer with 4" voice coil
- Adjustable crossover: 80Hz-200Hz
- 100Hz high pass filter output
- Integral phase switch 0° and 180°

DELTA-AX12 / AX-15 REAR PANEL LAYOUT

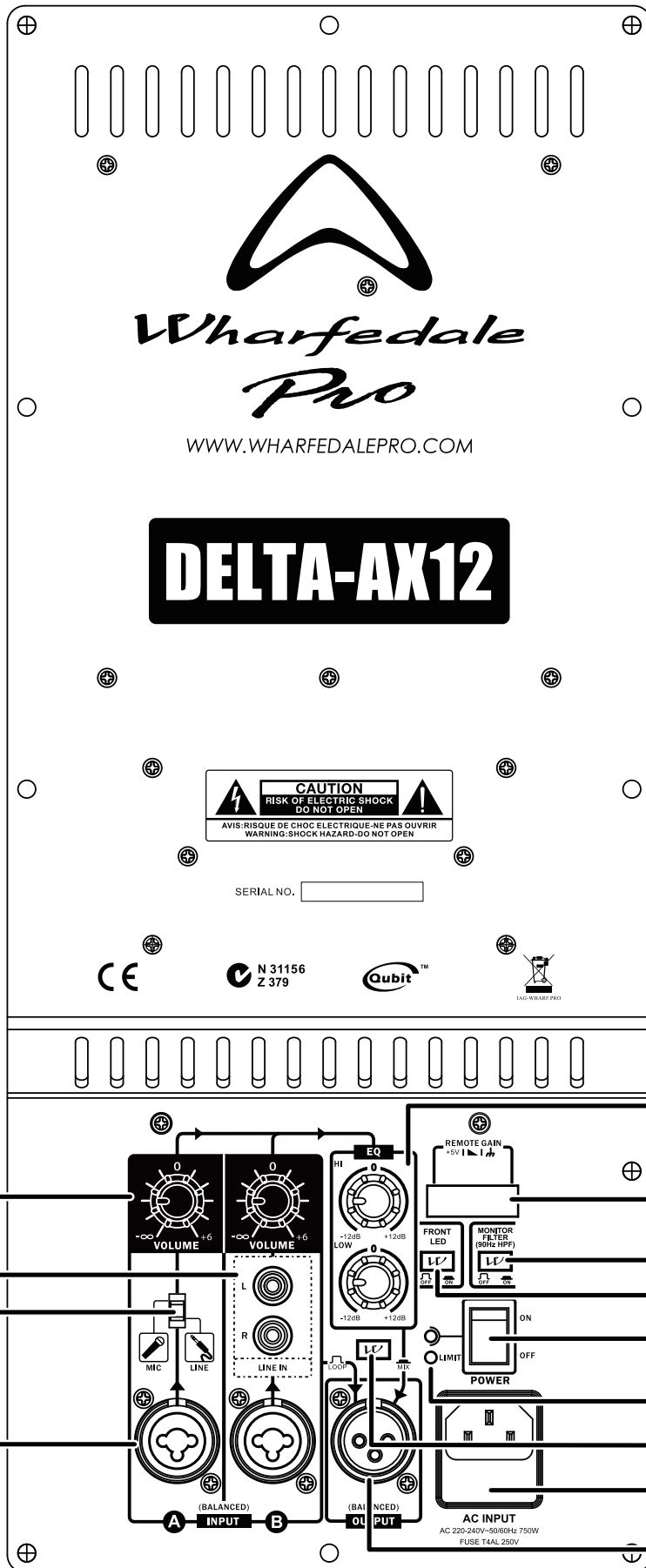

- 1. Volume for input A and input B:** These knobs control the level of each input channel.
- 2. RCA L/R (Left and Right) input connectors:** These connectors allow input of a stereo signal (left and right). The signal is actively combined or "summed" providing a mono signal to the amplifier.
- 3. GAIN selection switch:** This switch selects the proper gain structure for INPUT A. If a microphone is connected to INPUT A, use mic mode (up). If the signal source is anything other than a microphone (playback device, keyboard or mixer output, for instance) use the line mode (down).
- 4. XLR 1/4" COMBO input jacks for INPUT A and INPUT B:** These convenient jacks allow XLR or 1/4" balanced input connections to INPUT A and INPUT B.
- 5. HI and LOW EQ (equalization) controls:** These knobs control the equalization of the overall output signal providing +/-10dB of gain for each band.
- 6. Remote control:** This Phoenix connector can be used to control the volume with an applied voltage.
- 7. 90Hz Monitor filter switch:** Used to reduce bass buildup due to half space loading.
- 8. Front LED defeat switch:** Switches off the front power LED for discrete applications.
- 9 & 10. POWER ON / OFF switch, POWER 'ON' indicator LED and LIMIT indicator LED:** The switch: Turns the power on and off. The green LED to the left of the POWER switch illuminates when the power switch is in the 'ON' position. The red LED illuminates when the signal limiter is limiting the level of the signal to prevent distortion and overload.
- 11. Output source "LOOP/MIX" switch:** In the "LOOP" mode, this switch routes the signal of INPUT A and B to the line level XLR OUTPUT jack, bypassing the EQ section and volume control. When in the MIX mode, this switch routes the combined (or "mixed") signals of both INPUT A and INPUT B to the line level XLR OUTPUT jack.
- 12. POWER cord receptacle:** This is a receptacle for a standard IEC, three prong, grounded AC electrical connection cord. Be sure that you are plugging into the correct source voltage that matches what is indicated just below the power cord receptacle.
- 13. XLR line level OUTPUT connector:** This connector provides a balanced line level output for connection to additional Delta Active, powered subwoofers or amplifier.

DELTA-AX15B / AX-18B REAR PANEL LAYOUT

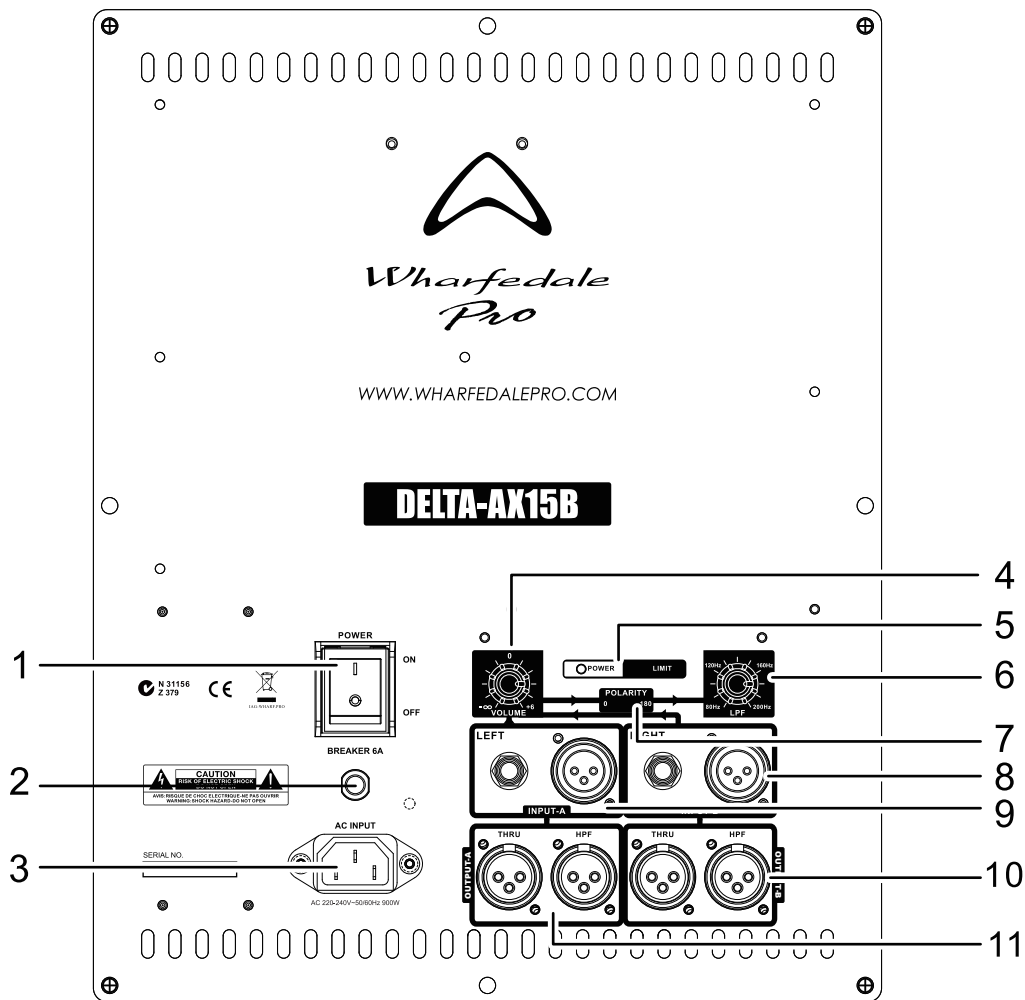

1. **Power switch:** Turns the power on and off.
2. **Circuit breaker:** Protect amplifier from damage caused by short circuit or other electrical destruction. Reset the breaker after the failure fixed.
3. **POWER receptacle:** This is the connection for the IEC AC power connector.
4. **Volume control:** Adjusts the volume.
5. **LIMIT LED POWER LED:** The red LED indicator illuminates when the signal limiting function is activated. The green LED indicator illuminates when the unit is powered up.
6. **Crossover frequency control:** Adjustable 80Hz to 200Hz.
7. **Phase switch:** Selects the polarity of the signal being sent to the subwoofer. 0° selects the signal polarity as it appears at the input. The 180° selection inverts the polarity of the signal.
8. **Input B:** TRS Jack and female XLR balanced for INPUT B.
9. **Input A:** TRS Jack and female XLR balanced for INPUT A.
- 10 & 11. **Output A & Output B:** Balanced male XLR connector provides output HIGH PASS signal. Selects the signal type that is routed to the OUTPUT connectors, "THRU" sends the unprocessed signal to the outputs. "HPF" filters the signal at 100Hz to the outputs.

DIMENSIONAL DRAWINGS

DELTA-AX12

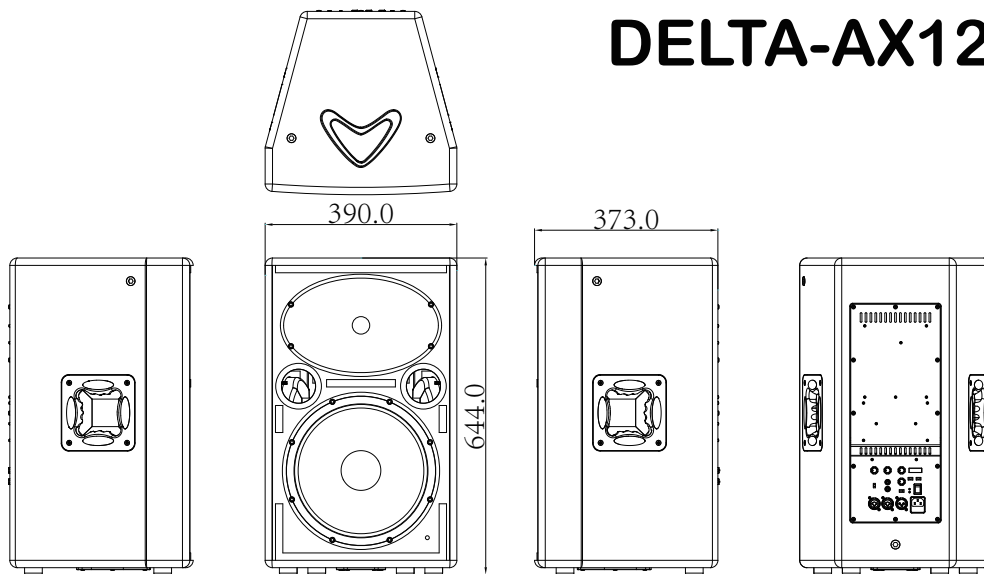

DELTA-AX15

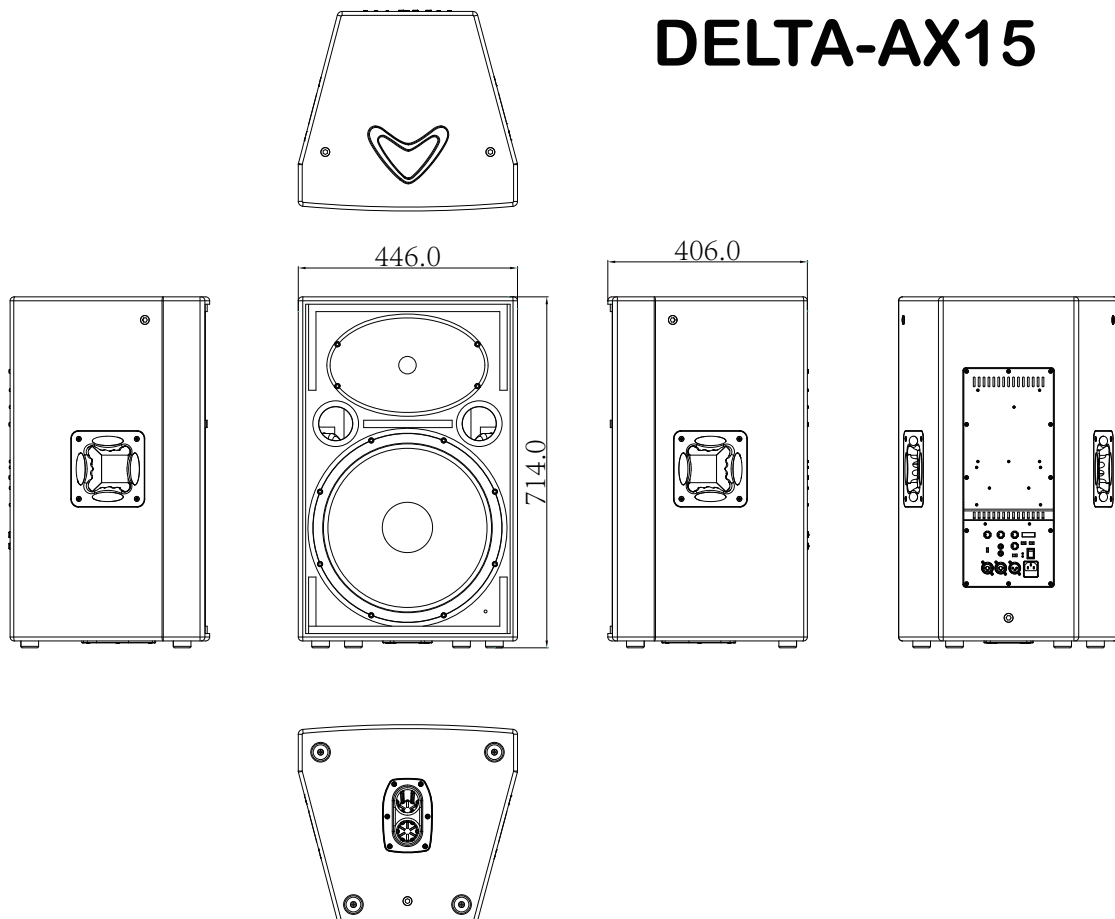

DIMENSIONAL DRAWINGS

DELTA-AX15B

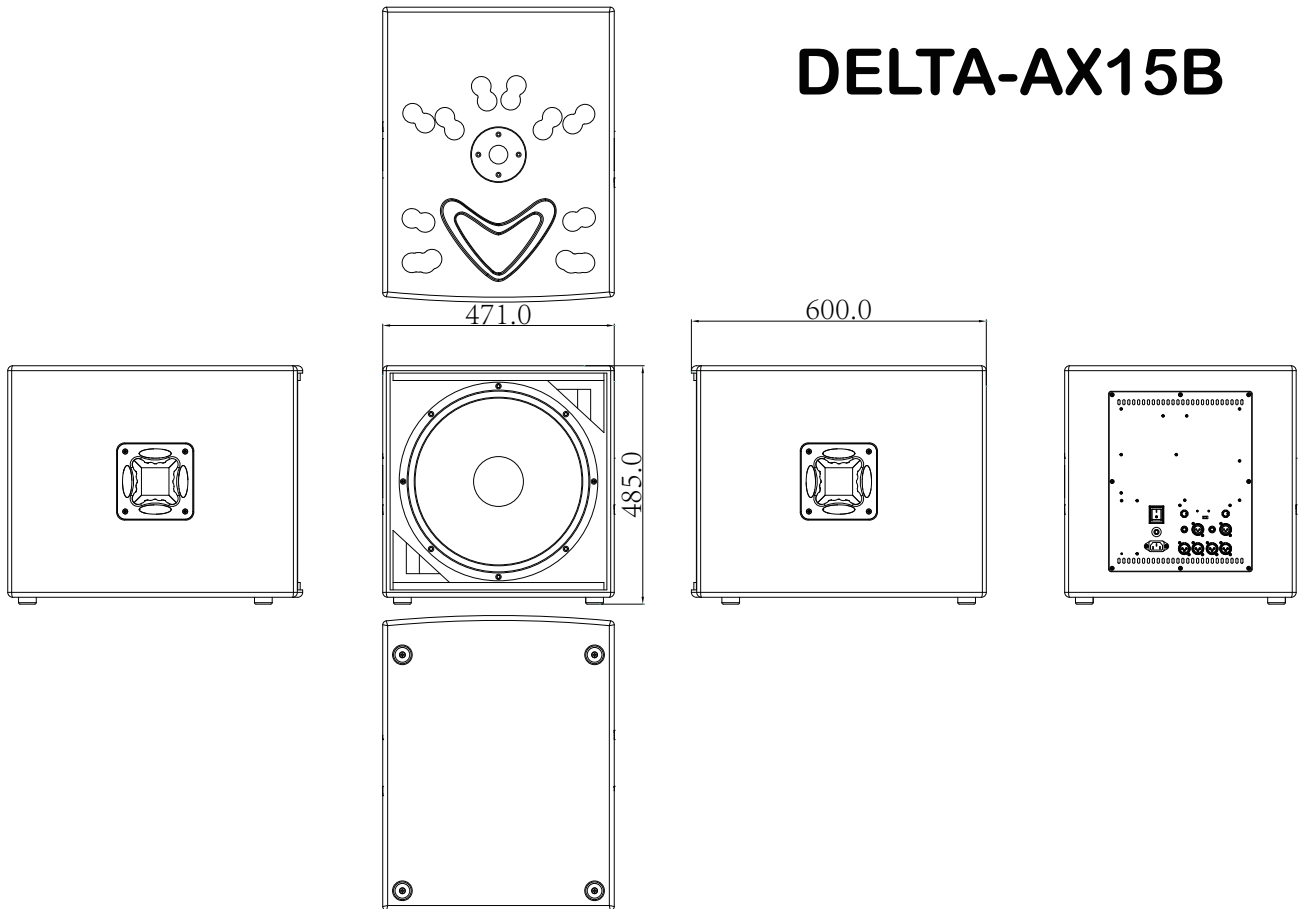

DELTA-AX18B

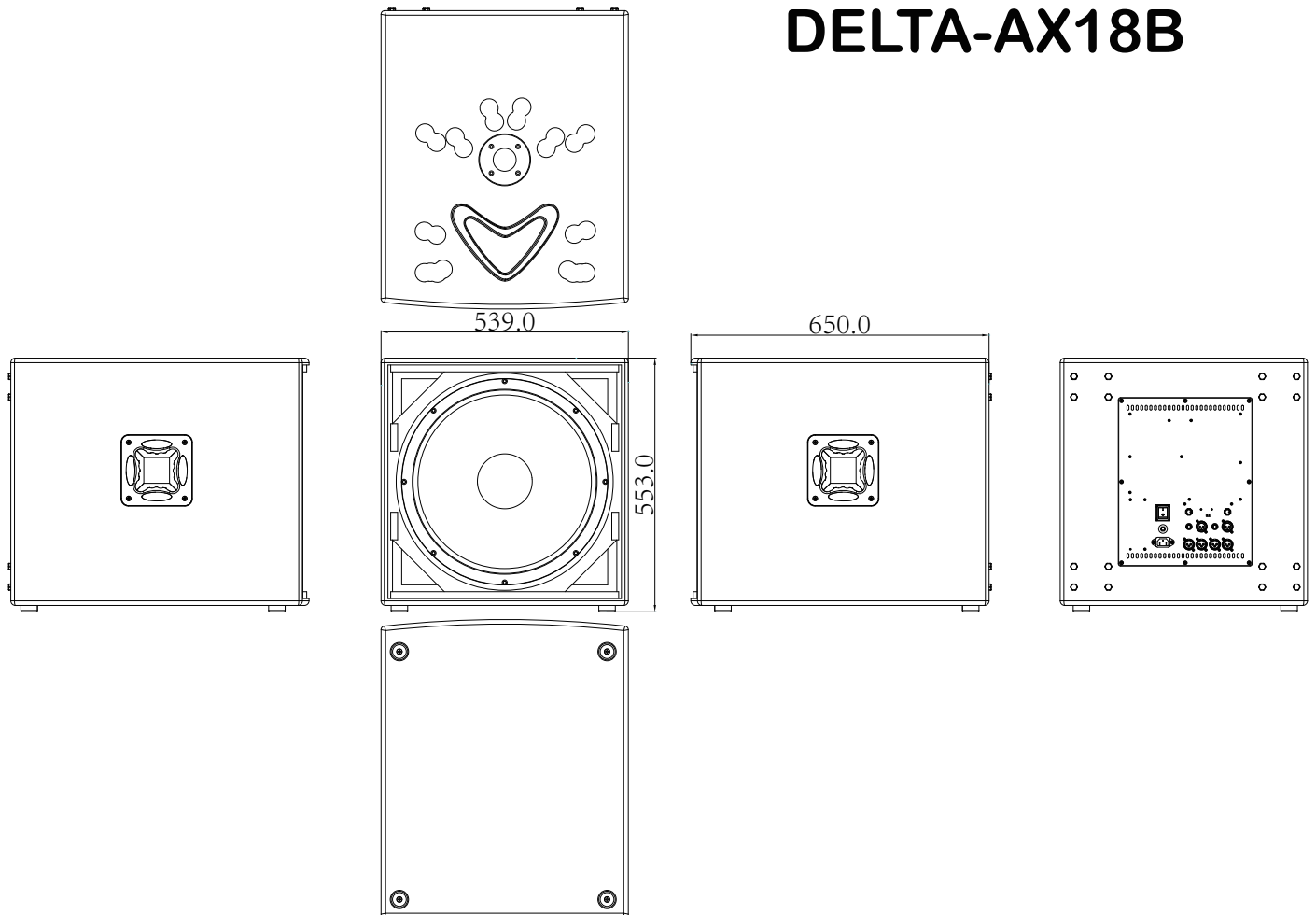

SPECIFICATION

Model Name	DELTA-AX12	DELTA-AX15	DELTA-AX15B	DELTA-AX18B
System Type	Active 12" 2-way Bi-Amplified	Active 15" 2-way Bi-Amplified	Active 15" Subwoofer	Active 18" Subwoofer
Frequency Response (+/-3dB)	60Hz - 20kHz	50Hz - 20kHz	42Hz - 200Hz	38Hz - 200Hz
Frequency Range (-10dB)	55Hz - 20kHz	45Hz - 20kHz		
Calculated Maximum SPL @1m	130dB	131dB	130dB	132dB
Low Frequency Transducer				
Size (mm / inches)	332mm / 12"	404mm / 15"	404mm / 15"	470mm / 18"
Coil Size (mm / inches)	75mm / 3"	75mm / 3"	101.6mm / 4"	101.6mm / 4"
Impedance	4 Ω	4 Ω	8 Ω	8 Ω
High Frequency Transducer				
Type	Compression Driver	Compression Driver	-	-
Coil Size (mm / inches)	51.2mm / 2"	51.2mm / 2"	-	-
Exit Size (mm / inches)	35.6mm / 1.4"	25mm / 1"	-	-
Diaphragm Material	Titanium	Titanium	-	-
Impedance	8 Ω	8 Ω	-	-
Nominal Coverage (H x V)	90° x 45°	90° x 45°	-	-
Amplifiers				
Low-Frequency Power Amplifier RMS	650w (Class D)	650w (Class D)	900W (Class D)	1000W (Class D)
High-Frequency Power Amplifier RMS	100W (Class D)	100W (Class D)	NA	NA
Amplifier Protection	Yes	Yes	Yes	Yes
Power On Protection	Power switch on/off mute	Power switch on/off mute	Power switch on/off mute	Power switch on/off mute
Thermal Protection	Amplifier Shut Down. Auto Reset	Amplifier Shut Down. Auto Reset	Amplifier Shut Down. Auto Reset	Amplifier Shut Down. Auto Reset
Low Line Voltage Shut Down	80% Nominal Line Voltage	80% Nominal Line Voltage	80% Nominal Line Voltage	80% Nominal Line Voltage
Driver Protection	Independent LF and HF Limiters	Independent LF and HF Limiters	Yes	Yes
DC and Short Protection	Yes	Yes	Yes	Yes
Clip Limiter	Turns on Approx 650w Output	Turns on Approx 650w Output	Turns on Approx 900w Output	Turns on Approx 1000w Output
Limiter Indicator	Red LED	Red LED	Red LED	Red LED
Power Indicator	Green LED	Green LED	Green LED	Green LED
Connectors				
Input A – type	Switchable Balanced Mic or Line Level Input	Switchable Balanced Mic or Line Level Input	Balanced	Balanced
Input Sensitivity	Mic:-40dBu Line:0dBu	Mic:-40dBu Line:0dBu	Line:0dBu	Line:0dBu
Maximum Input Level	22dBu	22dBu	22dBu	22dBu
Input Connector	XLR 1/4" Combo jack 2 x RCA	XLR 1/4" Combo jack 2 x RCA	TRS jack and Female XLR	TRS jack and Female XLR

SPECIFICATION

Model Name	DELTA-AX12	DELTA-AX15	DELTA-AX15B	DELTA-AX18B
Input Impedance	Balanced:20K Ω Unbalanced:10K Ω	Balanced:20K Ω Unbalanced:10K Ω	Balanced:20K Ω Unbalanced:10K Ω	Balanced:20K Ω Unbalanced:10K Ω
Line Output Connector	Switchable LOOP/MIX Balanced Male XLR Connector	Switchable LOOP/MIX Balanced Male XLR Connector	Male XLR Connector	Male XLR Connector
Impedance Balanced	Balanced: 200 Ω Unbalanced:100 Ω	Balanced: 200 Ω Unbalanced:100 Ω	Balanced: 200 Ω Unbalanced:100 Ω	Balanced: 200 Ω Unbalanced:100 Ω
Loop Gain	0dB	0dB	0dB	0dB
AC Power details - Power Supply	High Efficiency Switching Mode Power Supply	High Efficiency Switching Mode Power Supply	High Efficiency Switching Mode Power Supply	High Efficiency Switching Mode Power Supply
AC Power Options	AC100-120V~ 220-240V~, 50/60HZ	AC100-120V~ 220-240V~, 50/60HZ	AC100-120V~ 220-240V~, 50/60HZ	AC100-120V~ 220-240V~, 50/60HZ
Power On Indicator	Green LED	Green LED	Green LED	Green LED
Hardware - Rigging	M10 x 6	M10 x 6	-	-
Enclosure Material and finish	15mm Plywood	15mm Plywood	15mm Plywood	15mm Plywood
Colour Options	Black Rhino Paint	Black Rhino Paint	Black Rhino Paint	Black Rhino Paint
Grille Material & Finish	1.2 Steel	1.2 Steel	1.2 Steel	1.2 Steel
Unpacked dimensions - Height	640mm / 25.2"	700mm / 27.56"	471mm / 18.54"	539mm / 21.22"
Width (Front)	390mm / 15.35"	446mm / 17.56"	471mm / 18.54"	539mm / 21.22"
Width (Back)	241.2mm / 9.5"	281.4mm / 11.08"	471mm / 18.54"	539mm / 21.22"
Depth	373mm / 14.69"	406mm / 15.98"	600mm / 23.62"	650mm / 25.59"
Packed Dimensions - Height	745mm / 29.3"	803mm / 31.6"	556mm / 21.89"	624mm / 24.57"
Width (Front)	566mm / 22.3"	638mm / 25.1"	672mm / 26.46"	722mm / 28.43"
Width (Back)	328mm / 12.9"	366mm / 14.4"	672mm / 26.46"	722mm / 28.43"
Depth	464mm / 18.3"	498mm / 19.6"	543mm / 21.38"	611mm / 24.06"
Net Weight (kg / lbs)	27.9kg / 61.2lbs	33kg / 72.6lbs	33.1kg / 72.82lbs	38.4kg / 84.48lbs
Gross Weight (kg / lbs)	32.5kg / 71.5lbs	38.5kg / 84.7lbs	36.7kg / 80.74lbs	44.3kg / 97.46lbs

WHARFEDALE PRO LIMITED WARRANTY

Wharfedale Pro products are warranted of manufacturing or material defects for a period of three years from the original date of purchase. In the event of malfunction, contact your authorised Wharfedale Pro dealer or distributor for information.

Please be aware that the warranty details may differ from country to country. Contact your dealer or distributor for information (available at www.wharfedalepro.com). These terms do not infringe your statutory rights.



WHARFEDALE PROFESSIONAL

IAG House, 13/14 Glebe Road, Huntingdon, Cambridgeshire, PE29 7DL, UK
www.wharfedalepro.com

Wharfedale Professional reserves the right to alter or improve specifications without notice.
All rights reserved © 2023 Wharfedale Pro. Wharfedale Pro is a member of the IAG Group.